

A

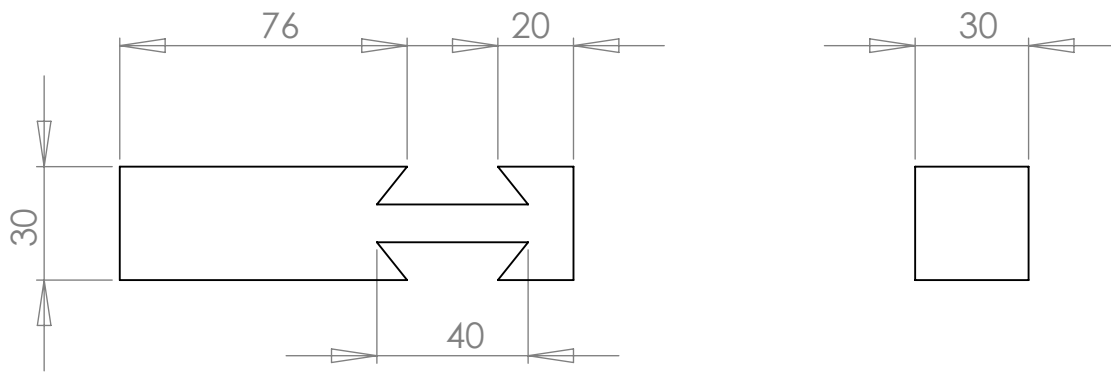

B

C

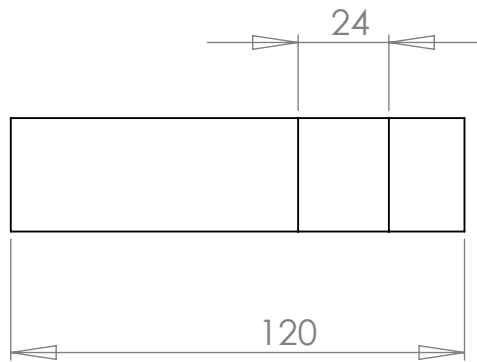

D

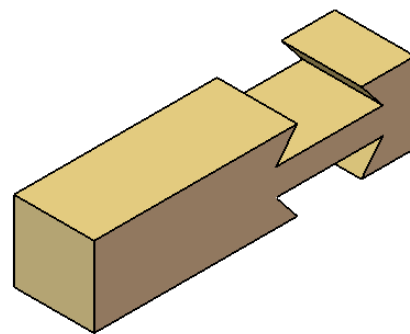

E

DIBUJADO POR:  
Antonio Pérez

EDICIÓN:  
00

**I.E.S. José Luis Castillo Puche**

REVISADO POR:

FECHA:  
12/12/2011

CÓDIGO:  
P3021



OBSERVACIONES:

MATERIAL:  
Pino

DESCRIPCIÓN:



A4

MASA:  
30.19

Escala:  
1:2

Hoja: 1 de 1