

DOBLADO DE PLANOS

A continuación vas a ver una serie de imágenes que muestran como realizar el plegado de planos para archivado sin fijación.

Este tipo de plegado se realizará cuando los planos deben ser archivados en archivadores, carpetas, porta-planos, etc. sin necesidad de quedar fijados a los mismos permitiendo de este modo un posterior manejo individual de cada plano en el taller o lugar de instalación.

El proceso de doblado de cualquier formato de dibujo sigue los siguientes pasos:

Pliegues longitudinales en zig-zag a partir del borde derecho de longitud 210 mm.

A excepción del formato A3, se realizan pliegues transversales en zig-zag a partir del borde inferior de longitud 297 mm.

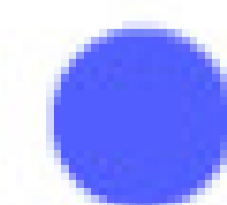

DOBLADO DEL FORMATO A3

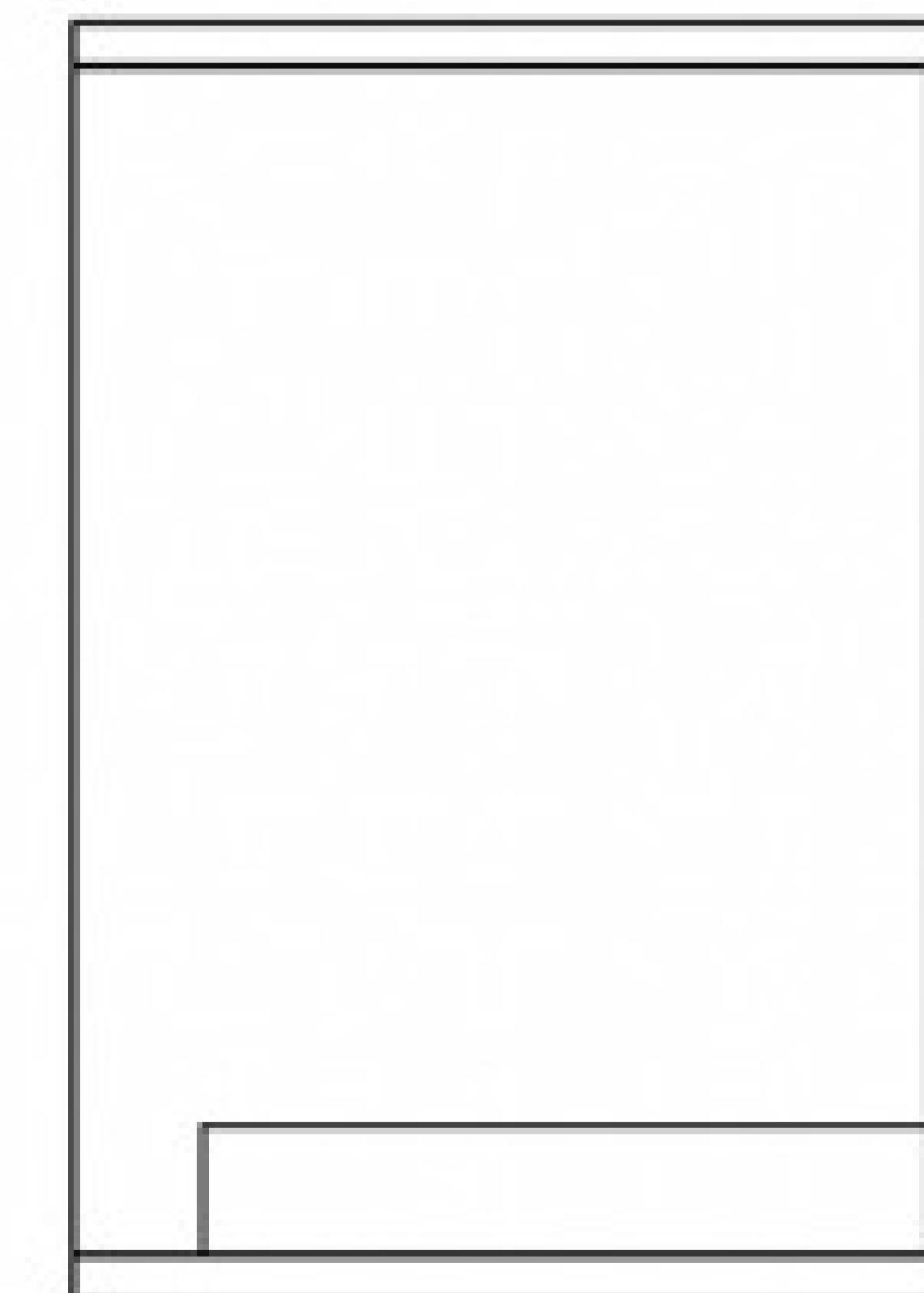
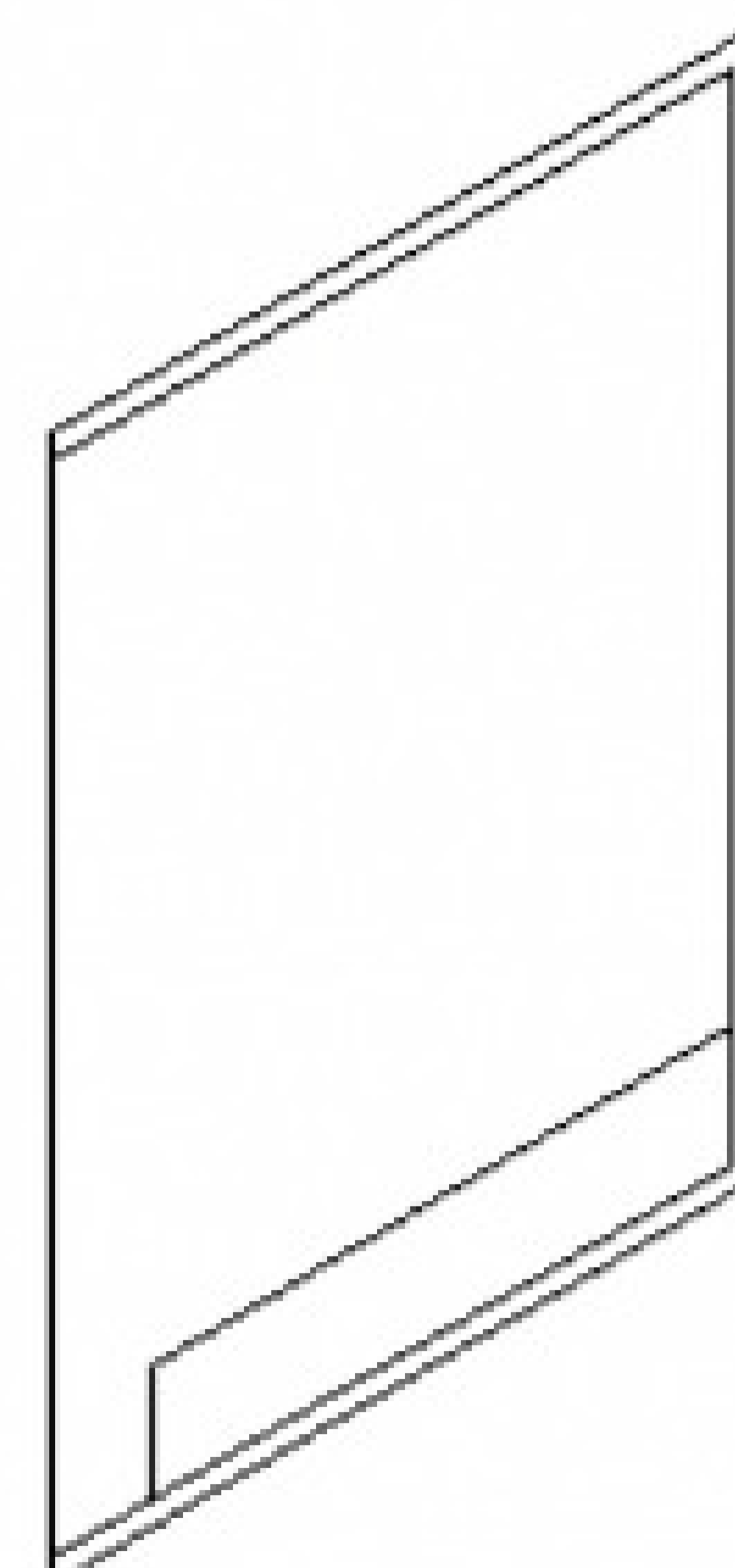
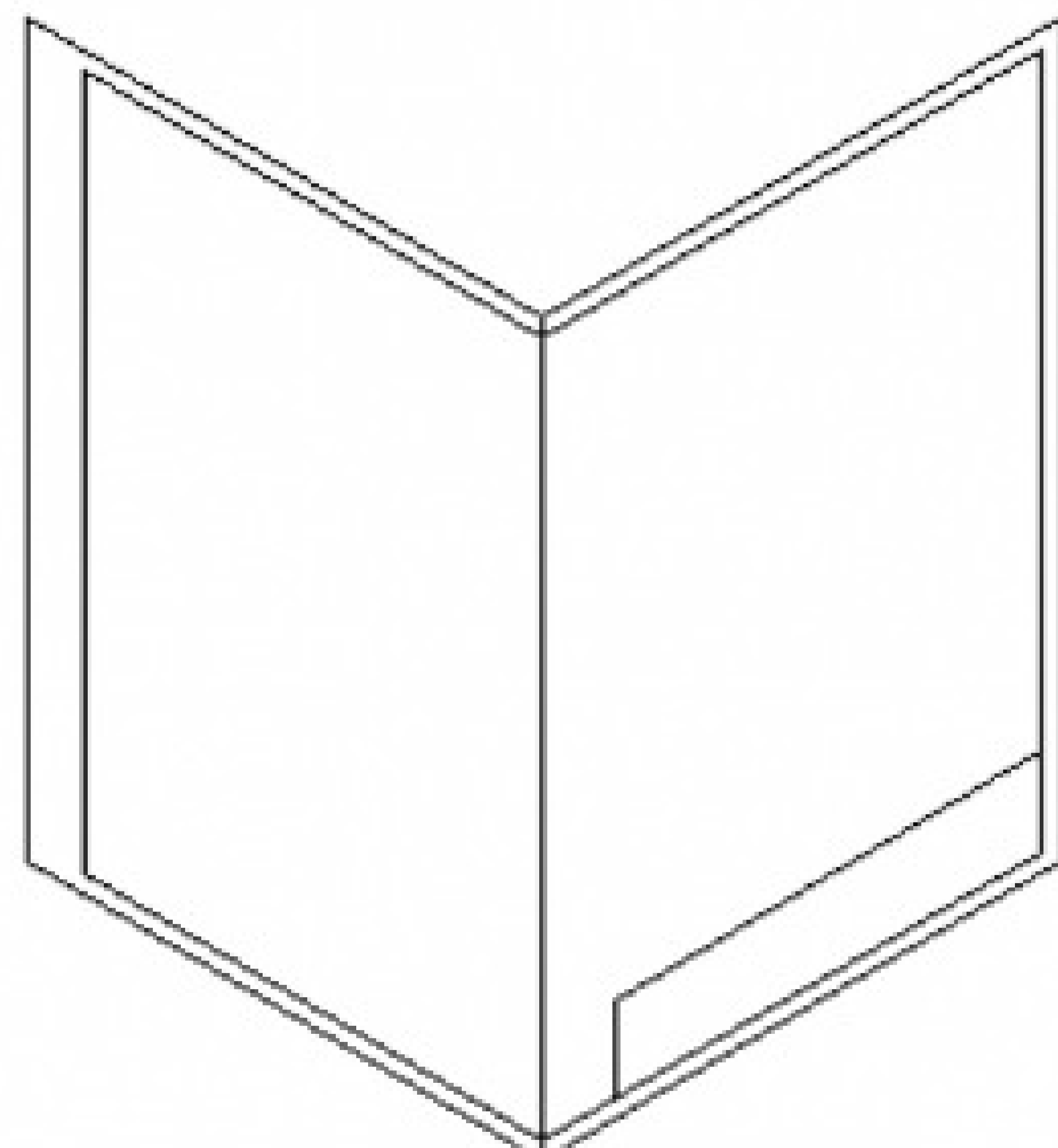
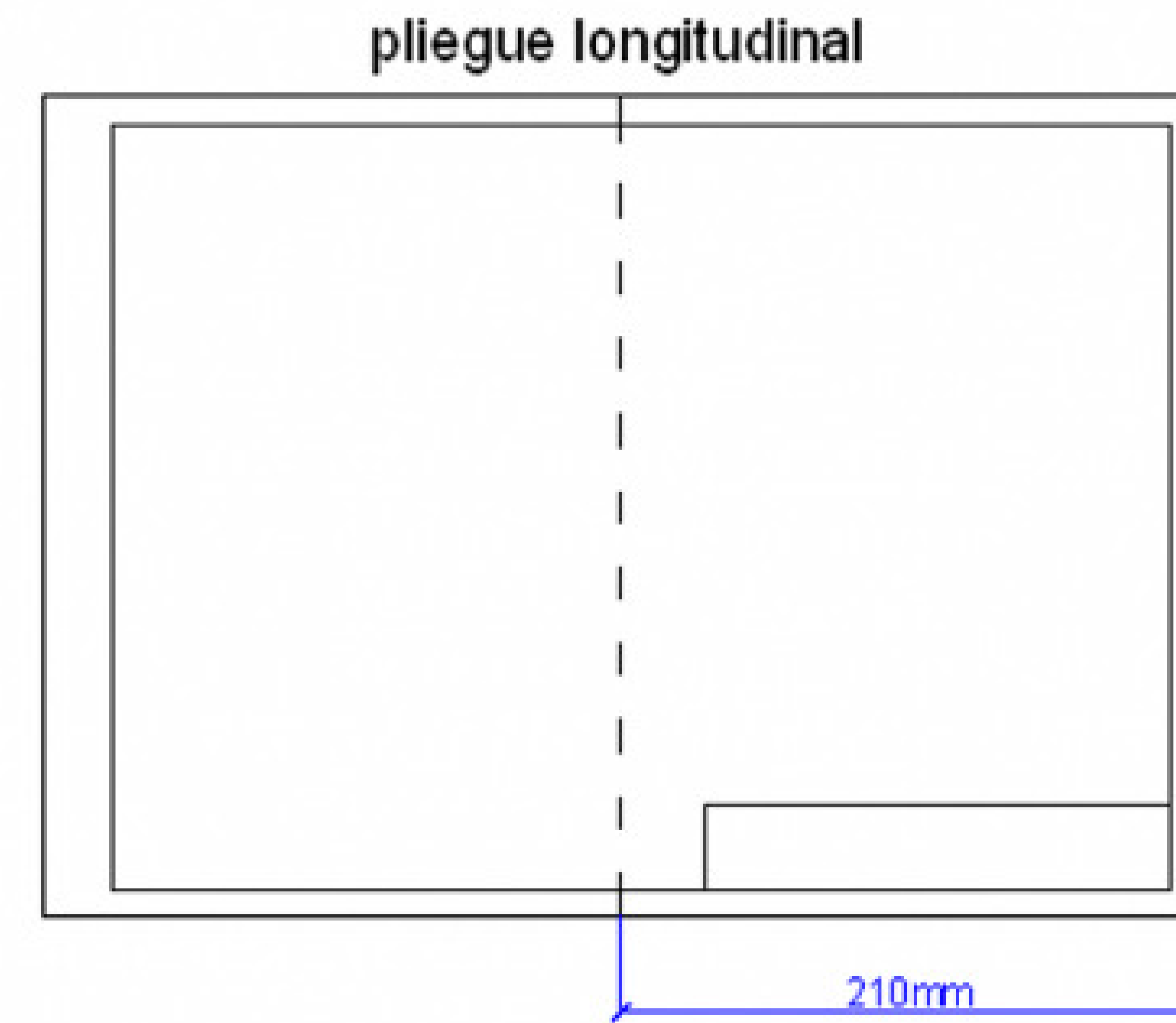
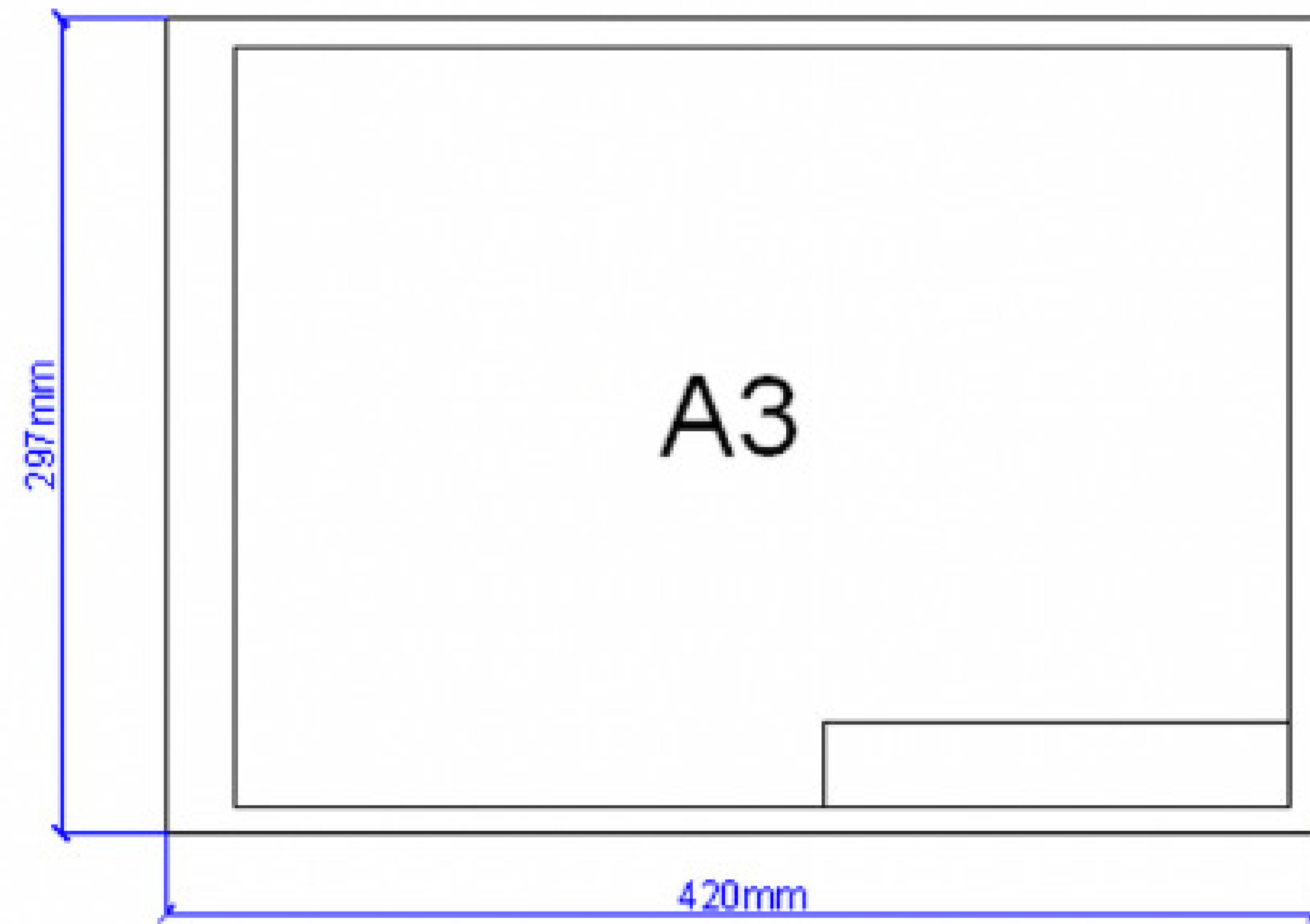

DOBLADO DEL FORMATO A2

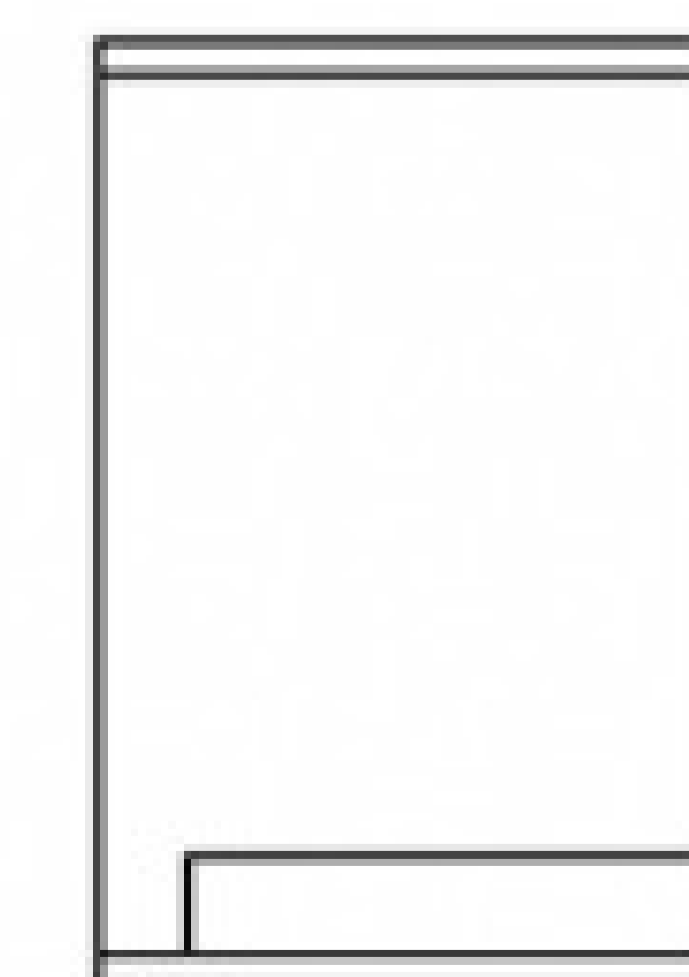
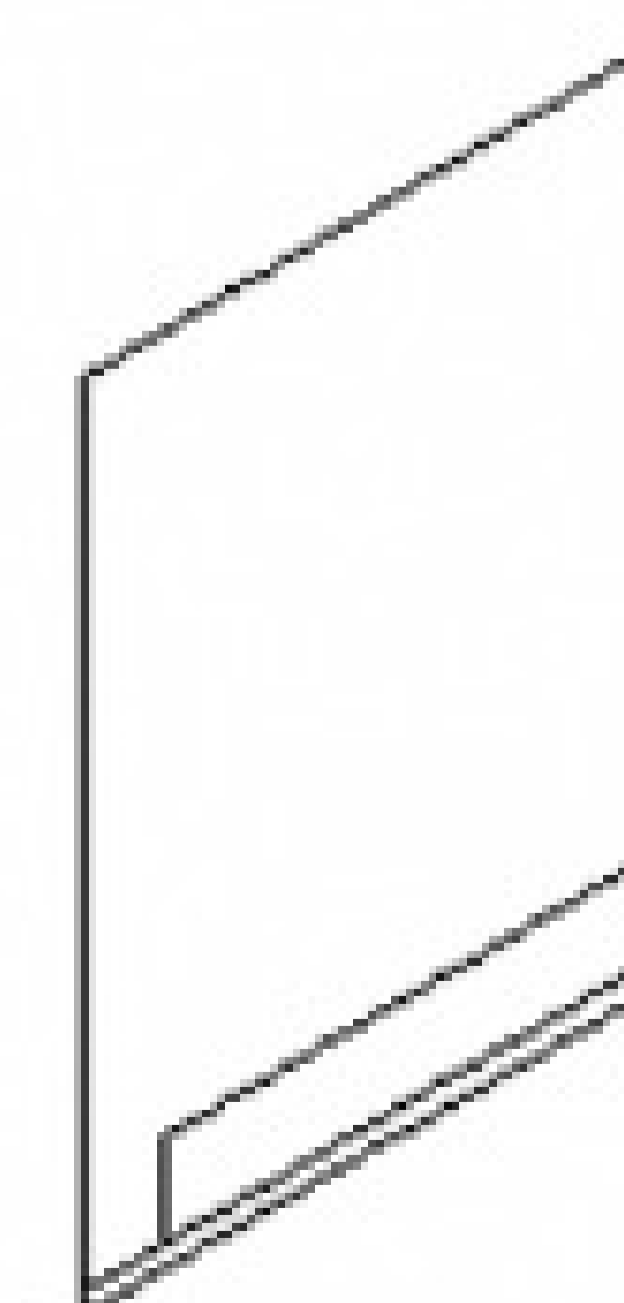
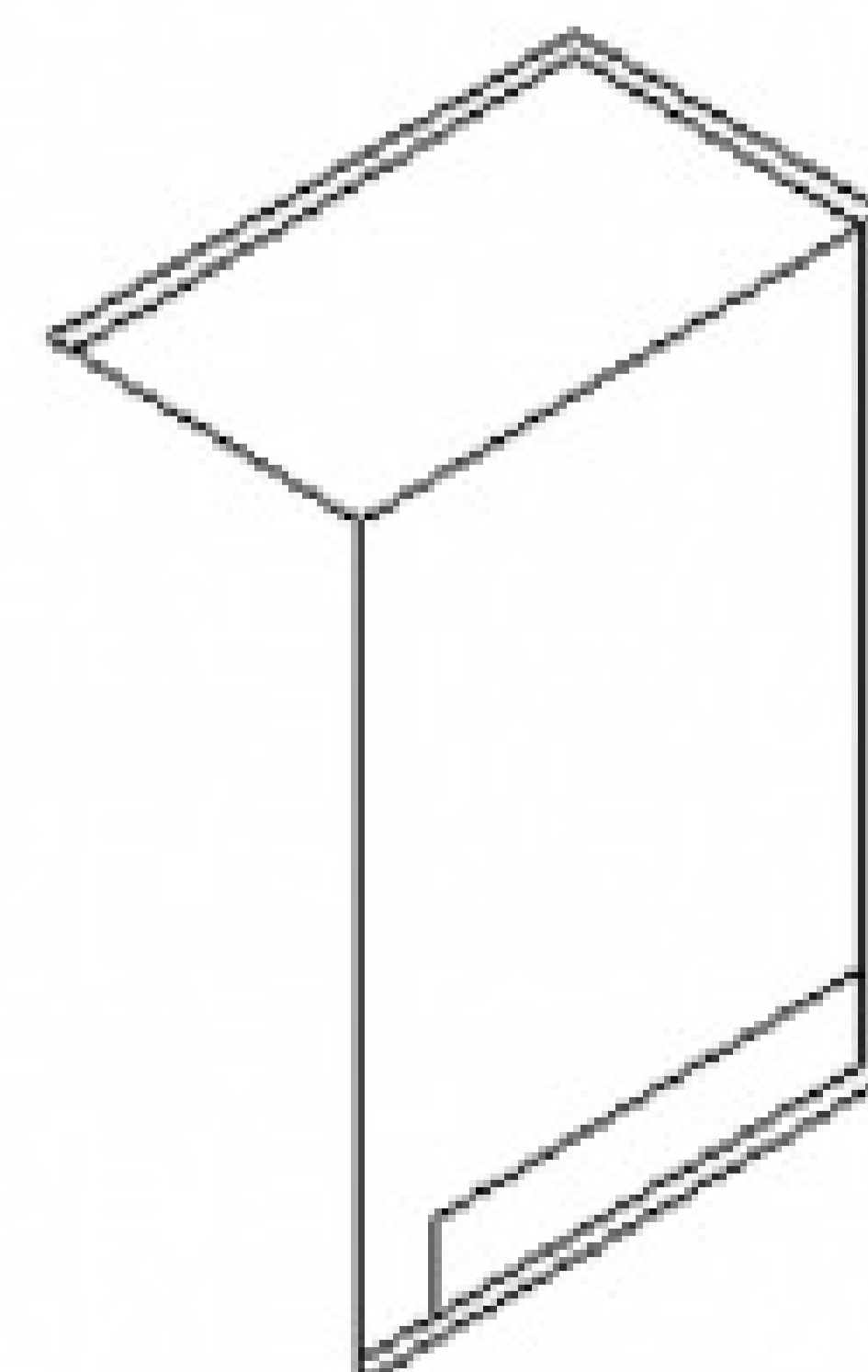
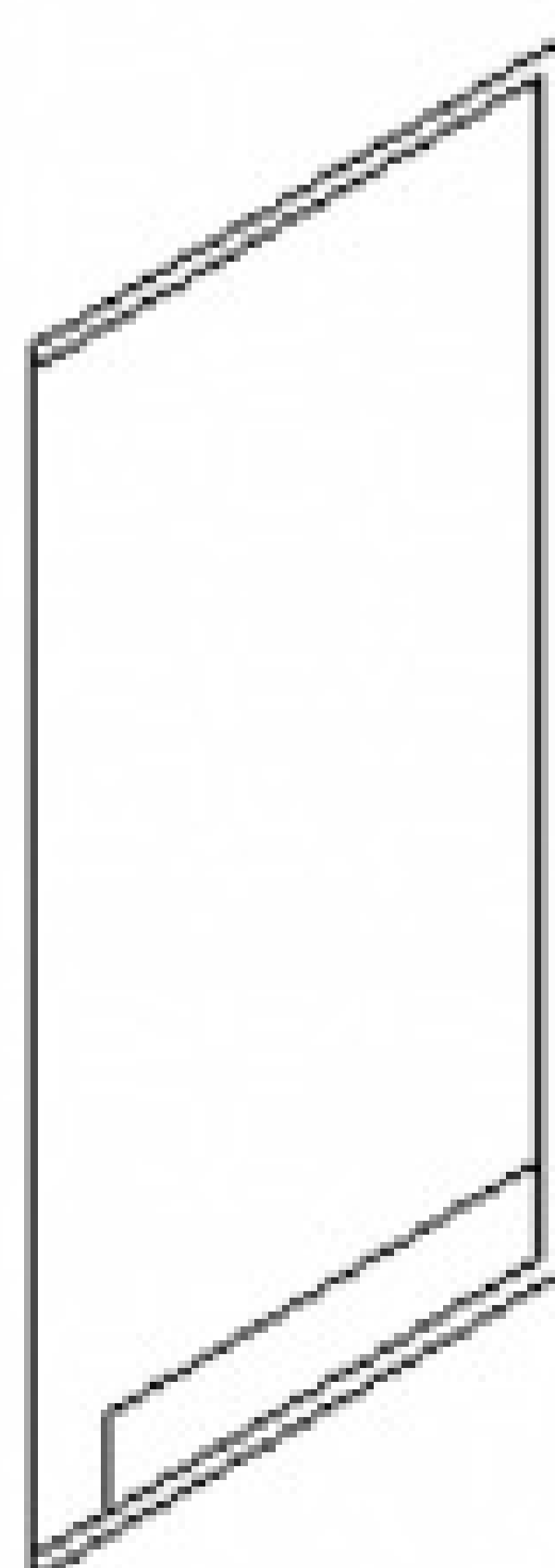
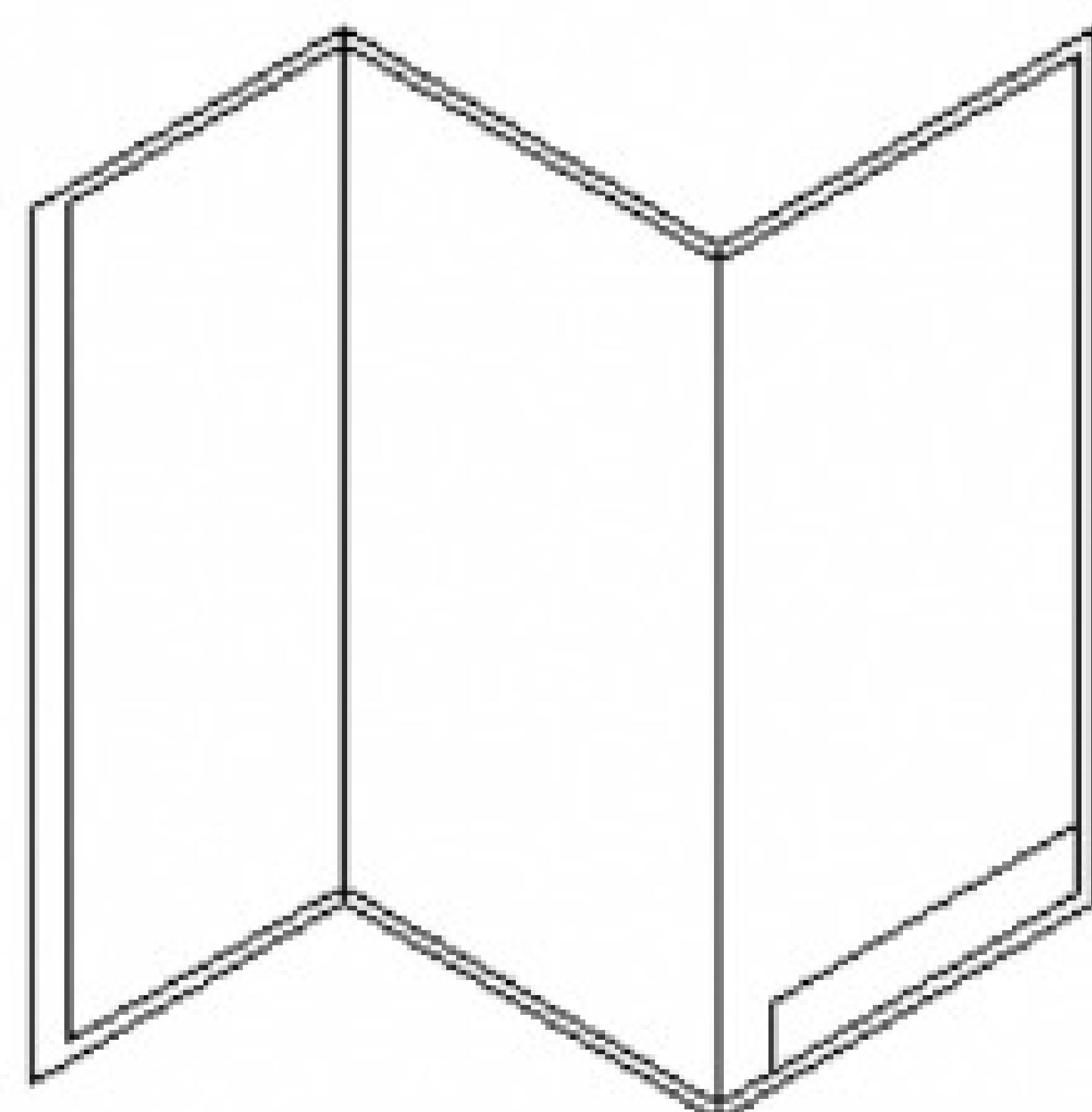
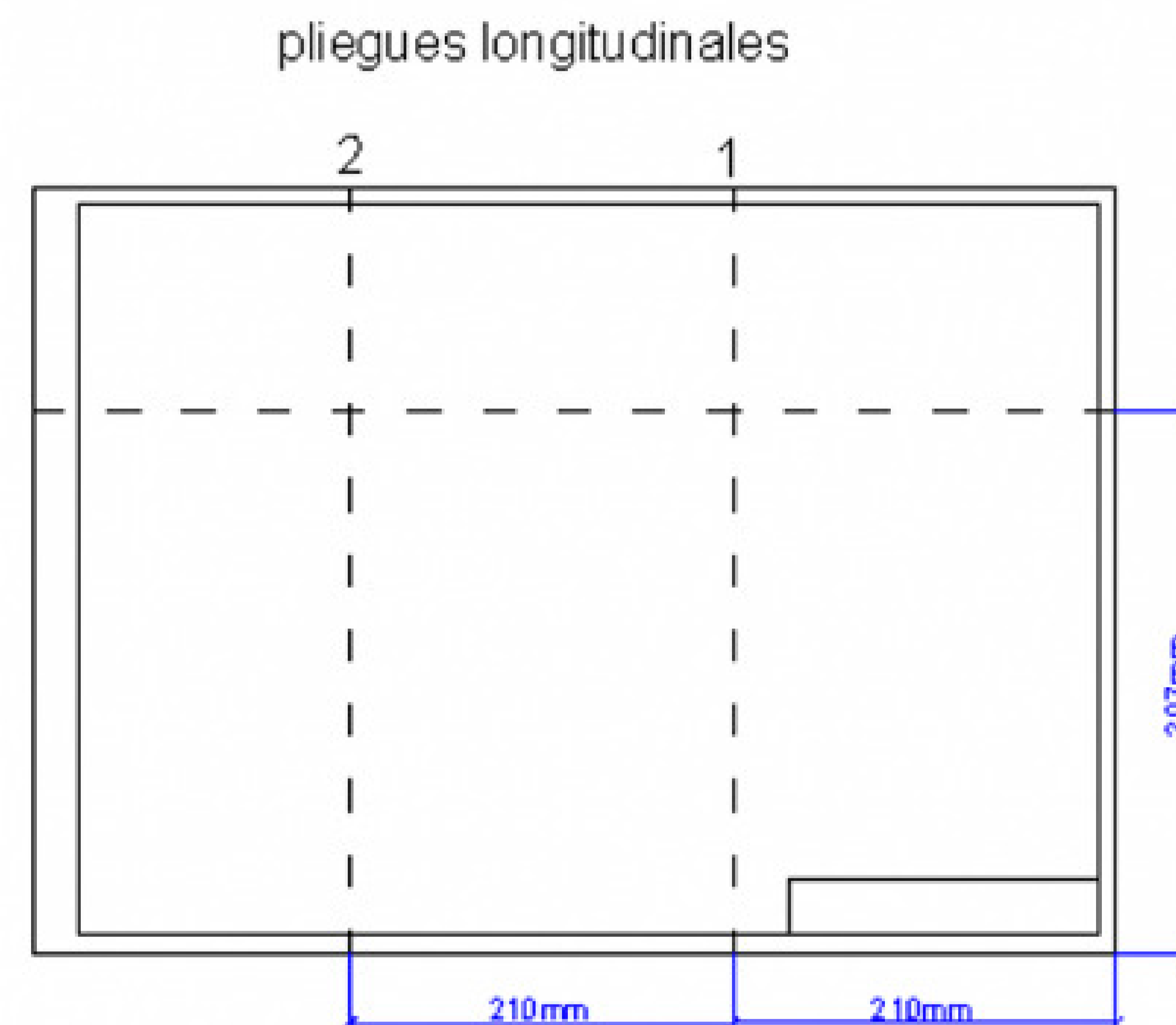
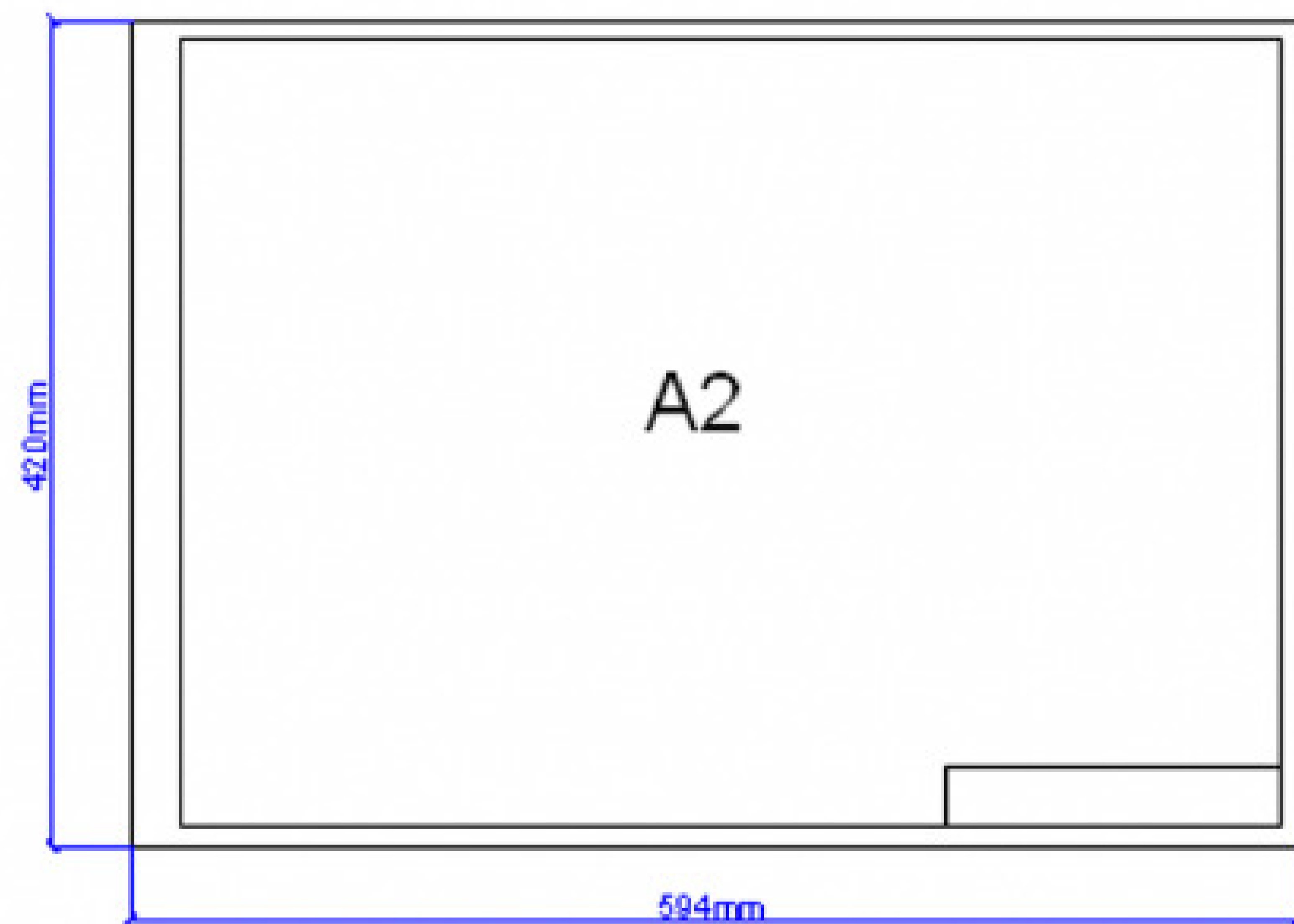

DOBLADO DEL FORMATO A1

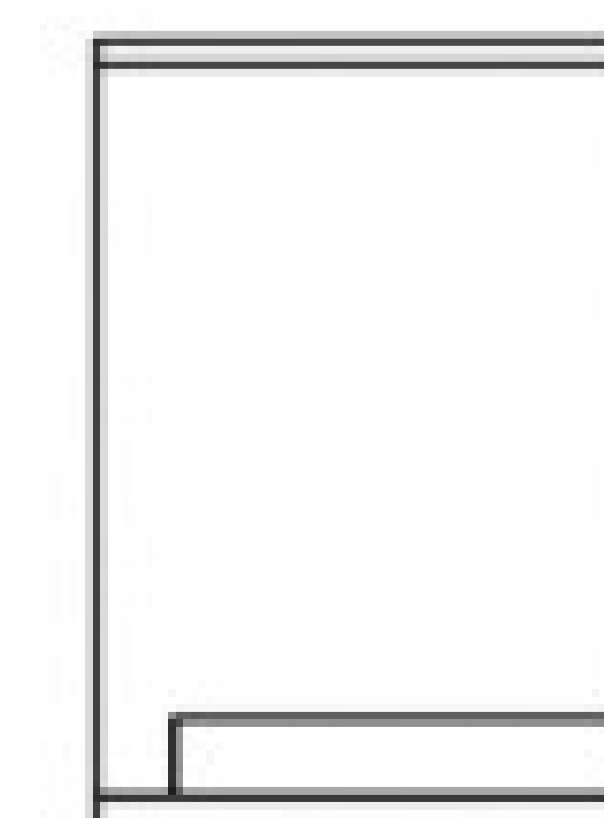
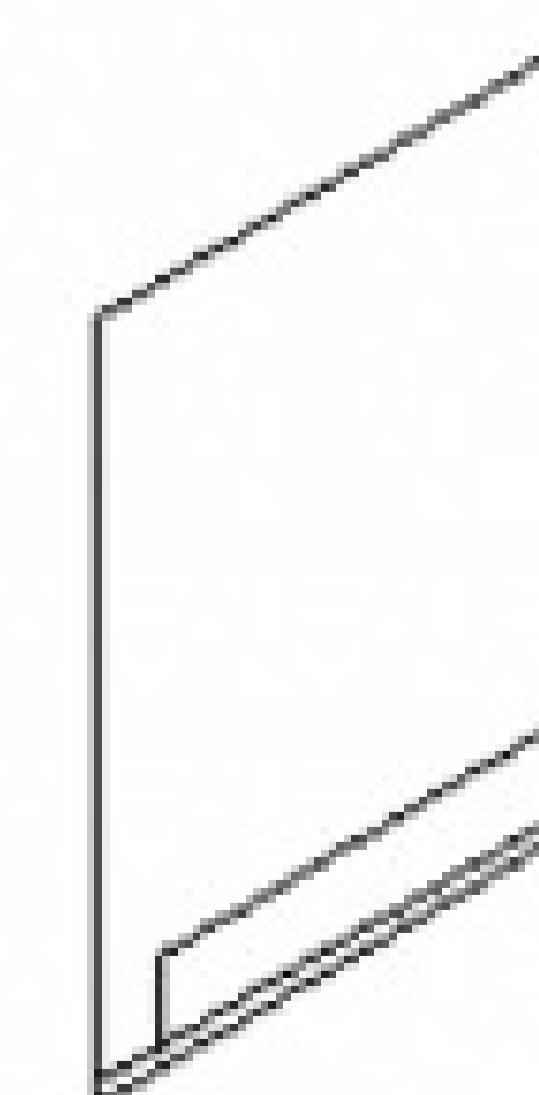
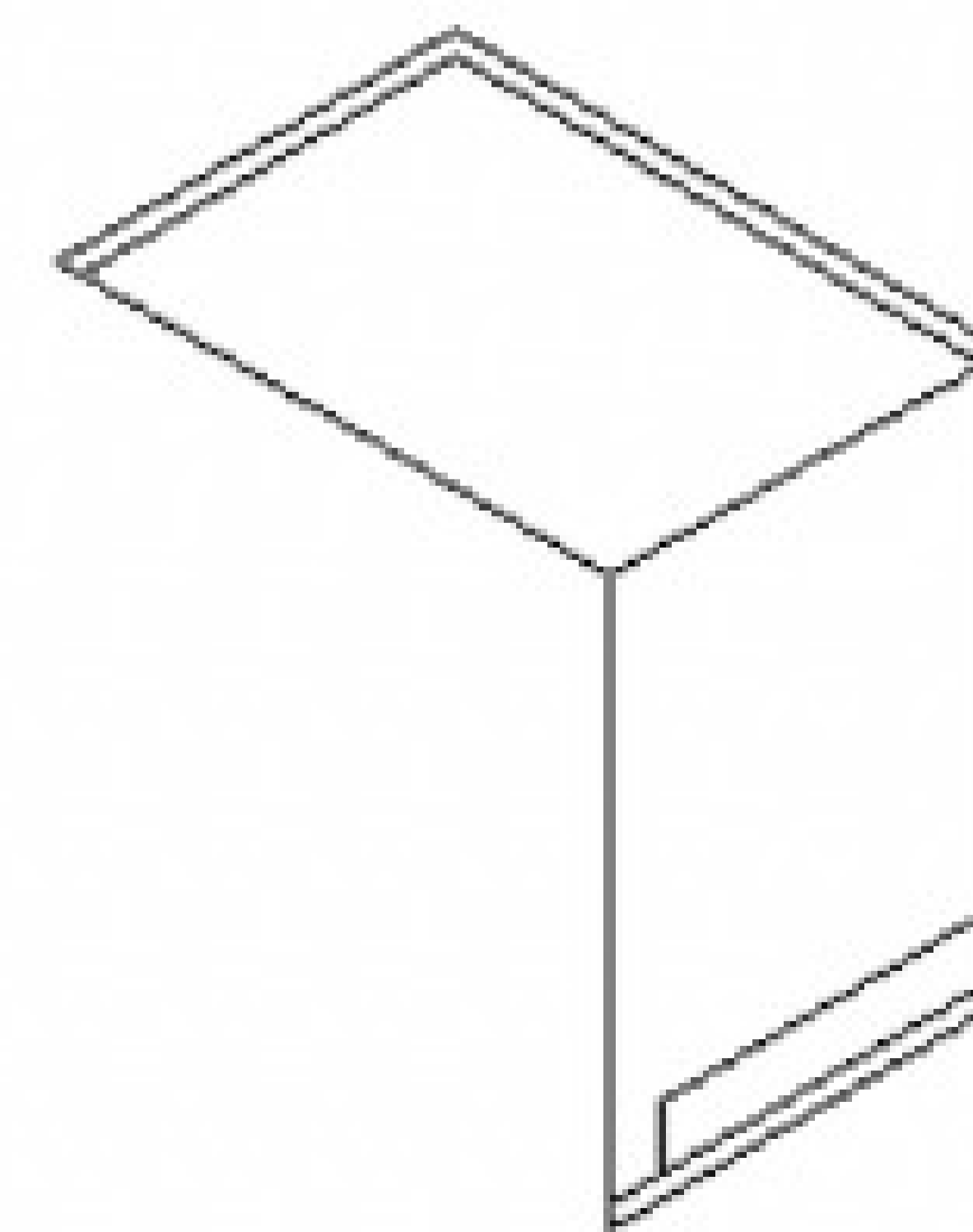
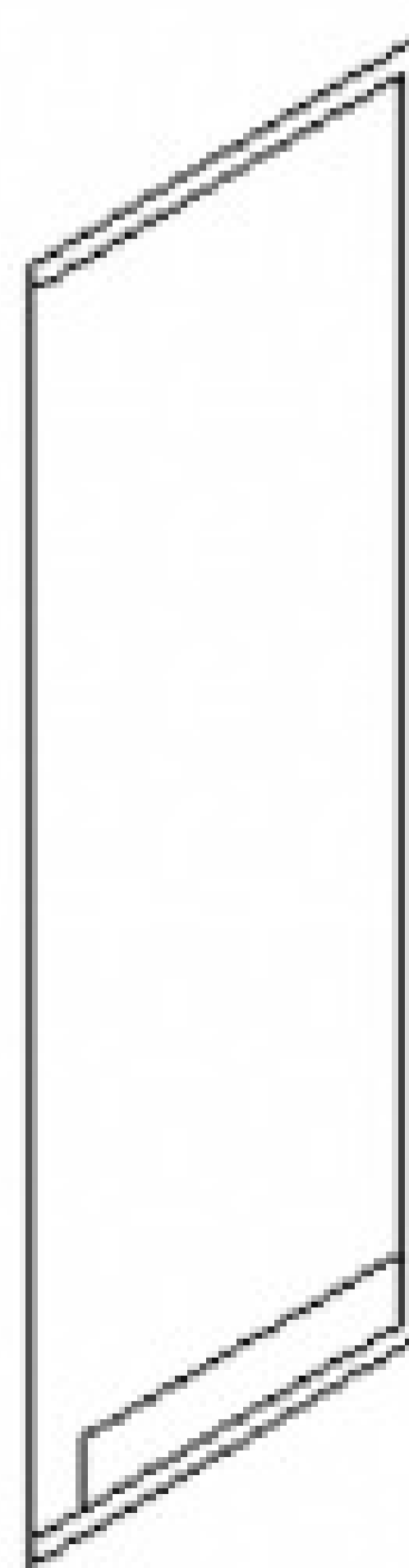
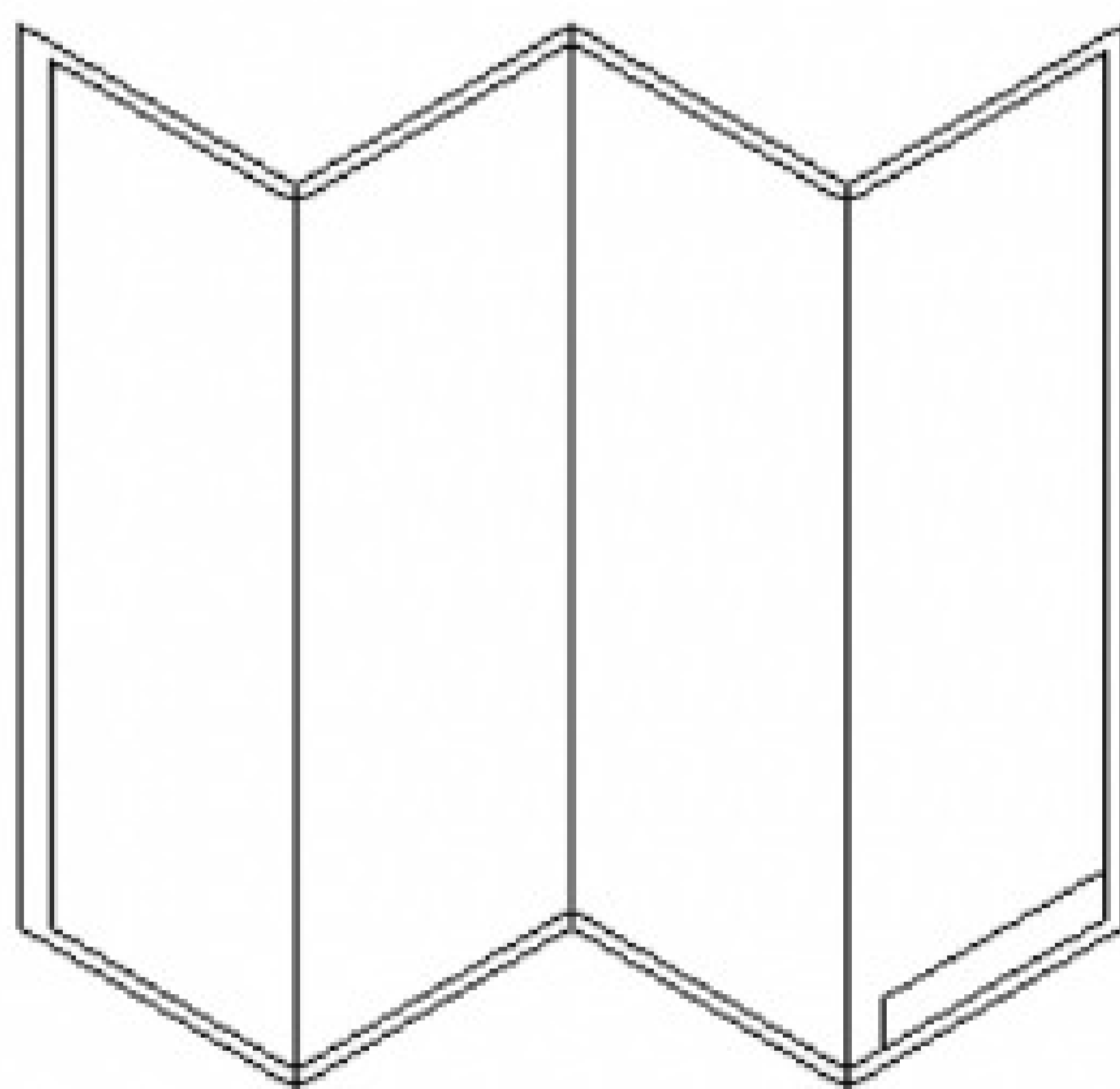
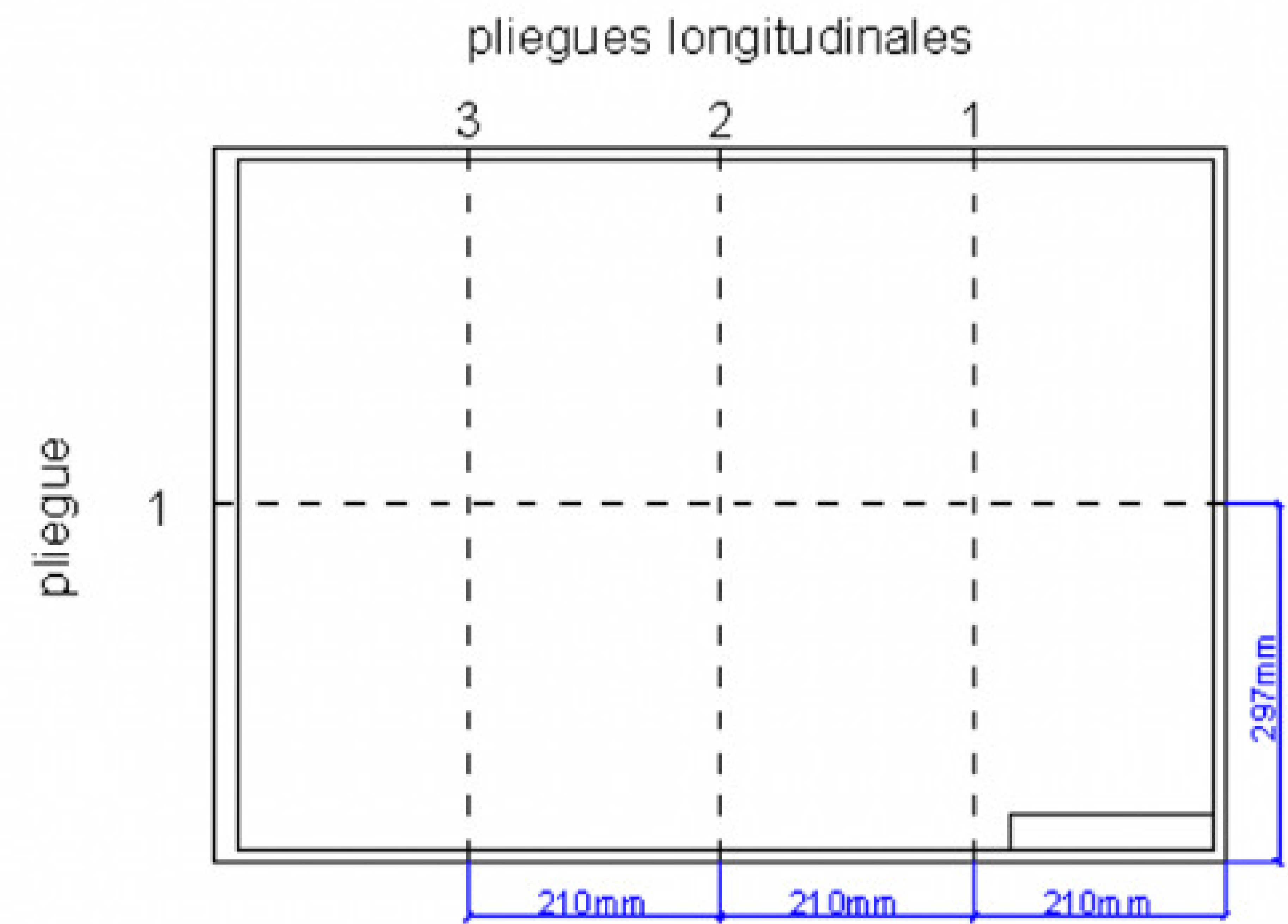
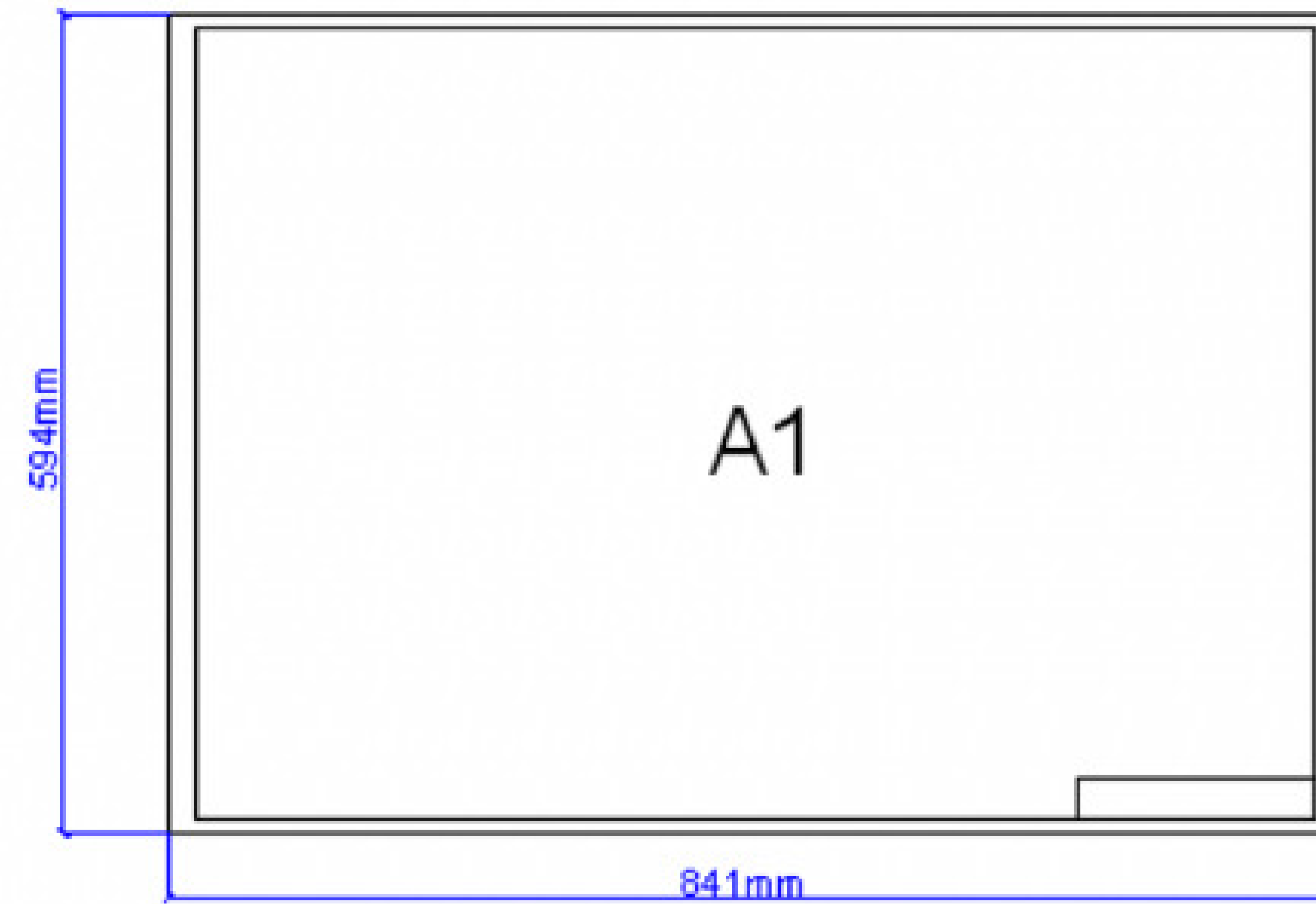

DOBLADO DEL FORMATO A0

